

Steel Rectangle Gazebo

Assembly Instructions - Please keep for future reference

Product Code: 16080



THANK YOU FOR CHOOSING THIS GARDEN COLLECTION PRODUCT.

Please read this instruction manual carefully before beginning to assemble the product. This is an important document, please read carefully and keep safely for future reference.

CAUTION

THIS BAG IS NOT A TOY.
PLASTIC BAGS CAN BE DANGEROUS.
TO AVOID DANGER OF SUFFOCATION,
KEEP THIS BAG AWAY FROM BABIES
AND CHILDREN.
DESTROY BAG BEFORE DISCARDING.

NECESSARY TOOLS

Please check the package contents before attempting to assemble this product. A full checklist of components is given in this leaflet. If any components are missing, please contact the retailer from whom you bought this product.

 The fittings pack contains SMALL ITEMS that could be swallowed, these parts should be **KEPT AWAY FROM YOUNG CHILDREN.**

DISTRIBUTED BY

United Hardware,
Magna Drive, Magna Business Park,
Citywest Road, Dublin 24,
Ireland - D24 KX97

 info@unitedhardware.ie

 www.unitedhardware.ie

Assembly Instructions

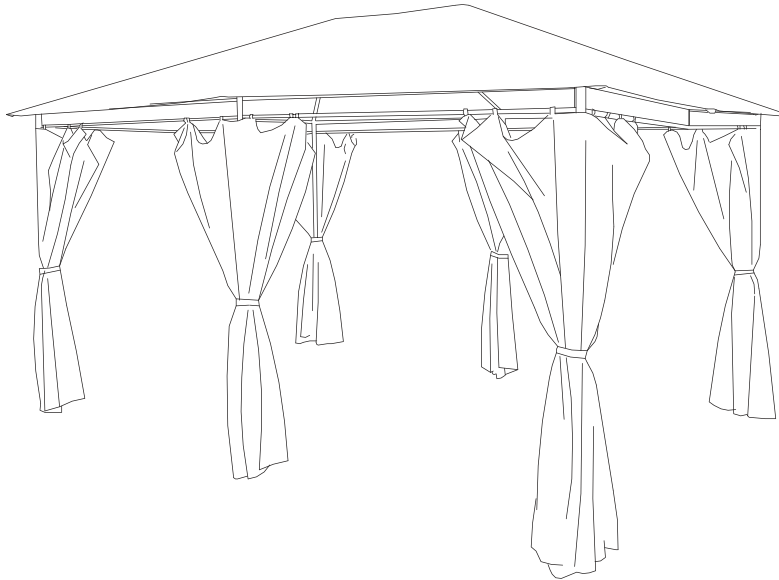

This Gazebo is intended for domestic use only.

We recommend assembly by four or more capable adults under light or no wind conditions.

CARE TIPS

Cleaning: Clean with a damp cloth, do not use bleach or harsh chemicals

Storage: Do not leave this product up in windy conditions, use only in light or no wind. Store in a cool dry place. Avoid exposure to moisture to prevent rust.

Inspection: Ensure that the product is erected correctly before use and that all hardware is tightened before each use.

SAFETY STATEMENTS AND WARNINGS

Do not use this gazebo under windy conditions. Always secure the gazebo while using.

This is not a permanent structure and should be disassembled and stored away

Do not repack your gazebo if wet, allow to dry completely first.

FIRE PRECAUTIONS

Do not use firepits, gas or electric heaters, candles, radiators or any other type of heat or fire source, or flammable liquid in or around the gazebo.



Do not use naked flames in or around the gazebo.

Do not cook or use a BBQ in or around the gazebo





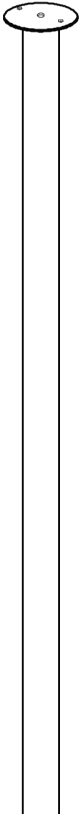
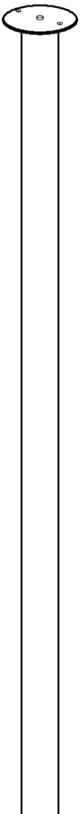
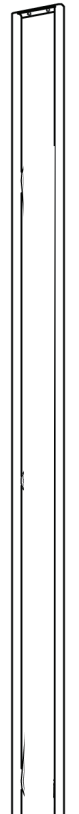
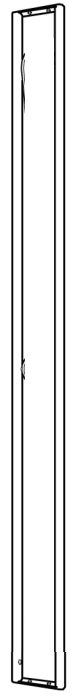
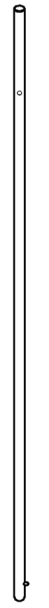

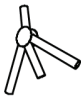
WARNING

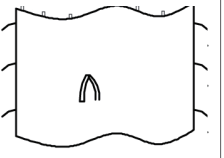
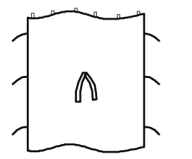
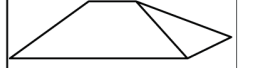
The manufacturer and seller disclaim any and all liability from personal injury, property damage or loss, whether direct or indirect or incidental resulting from the incorrect assembly, improper use, inadequate maintenance or neglect of this product.

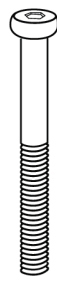
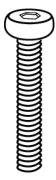
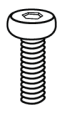
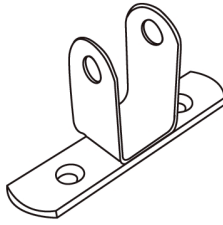
Assembly Instructions

A	B	C	D	E	F	G	H
							
Standing tube I	Standing tube II	Beam I	Beam II	Top bar I	Top bar II	Top center bar	Top fitting
4	2	4	4	4	4	1	2

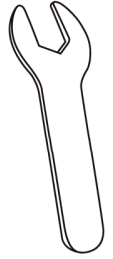
I		4
K		2
L		1

M	N	O	P	Q	R	S	T	U
								
Bolt I	Bolt II	Bolt III	Connector	Washer	Nut	Cap	Wrench	Allen wrench
4	12	20	2	56	20	20	1	1

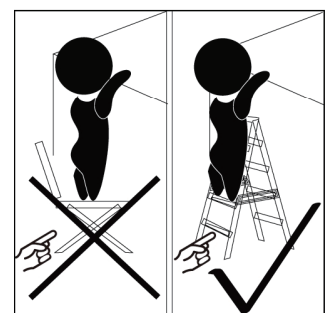
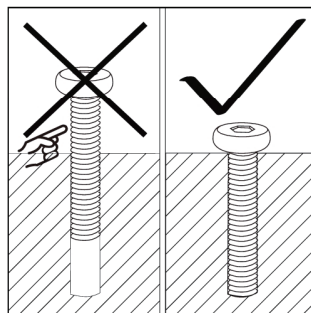
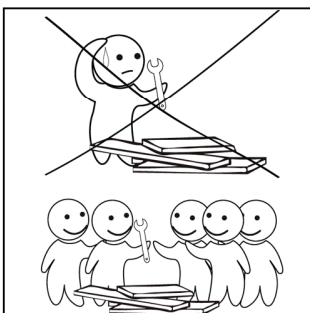

Assembly Instructions

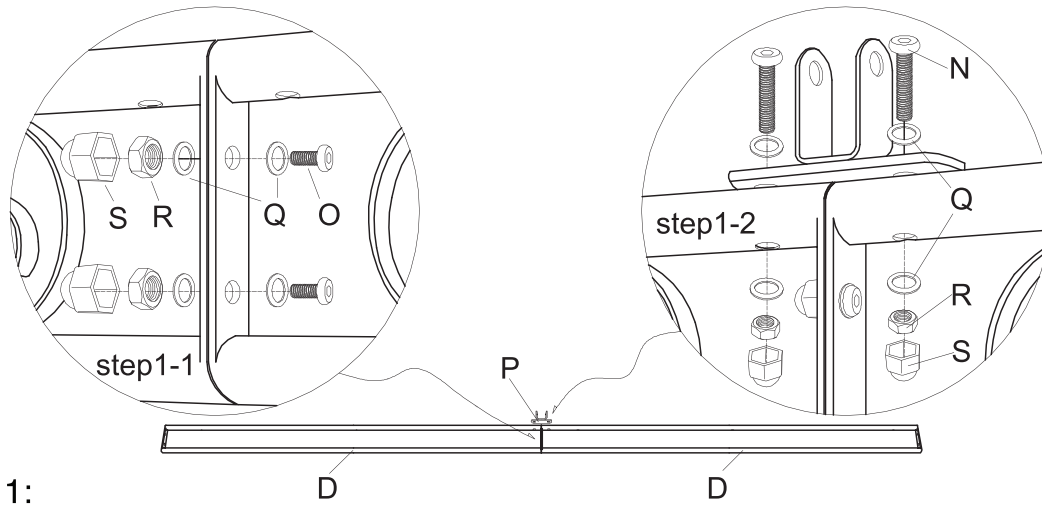

Step 1:

- Connect 2pcs Beam II (D) with Bolt III (O), Washer (Q), Nut (R) and Cap (S) as step 1-1
 - Fix Connector (P) on the connection part with Bolt II (N), Washer (Q), Nut (R) and Cap (S) as step 1-2
- Repeat this step for the other side

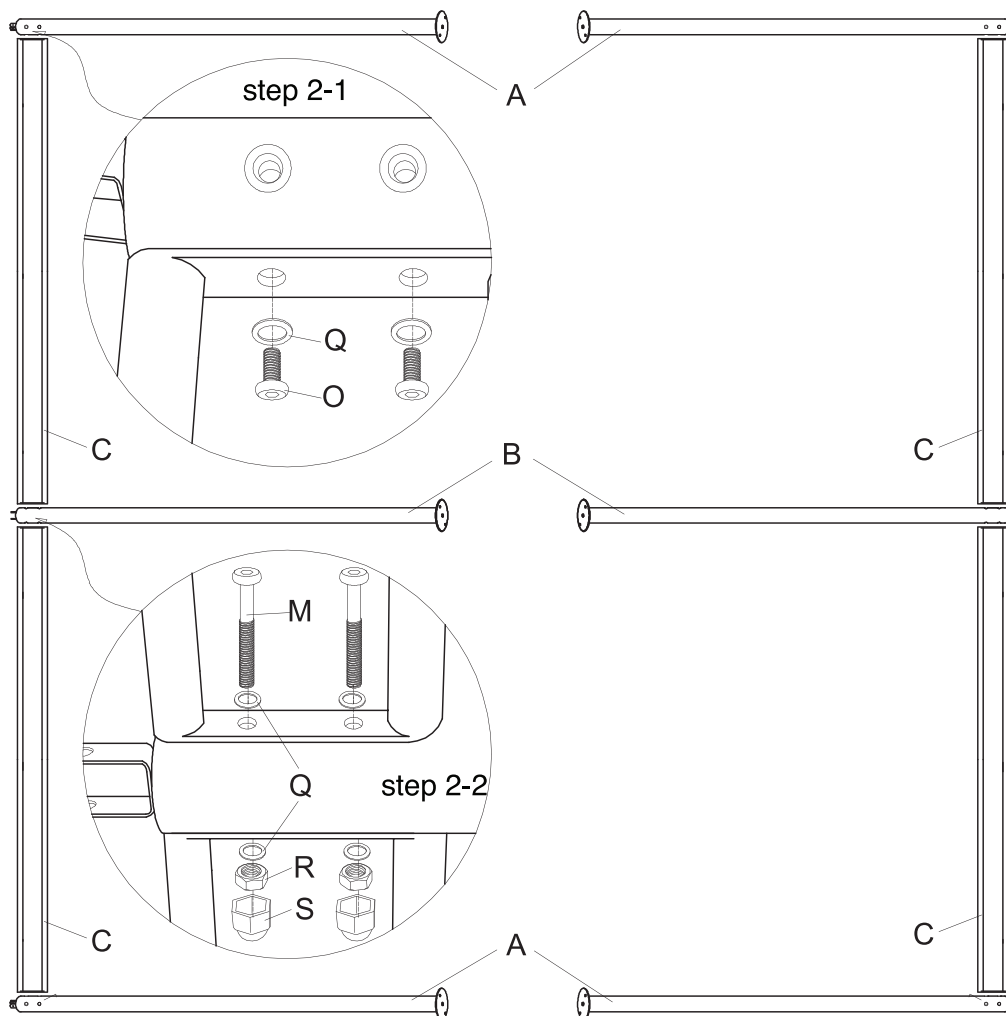

Step 2:

- Put Beam I (C) between Standing tube I (A) and Standing tube II (B), then attach each other:
- Attach Standing tube I (A) and Beam I (C) with Bolt III (O) and Washer (Q) as step 2-1
 - Attach Standing tube II (B) and Beam I (C) with Bolt I (M), Washer (Q), Nut (R) and Cap (S) as step 2-2
- Repeat this step for the other side

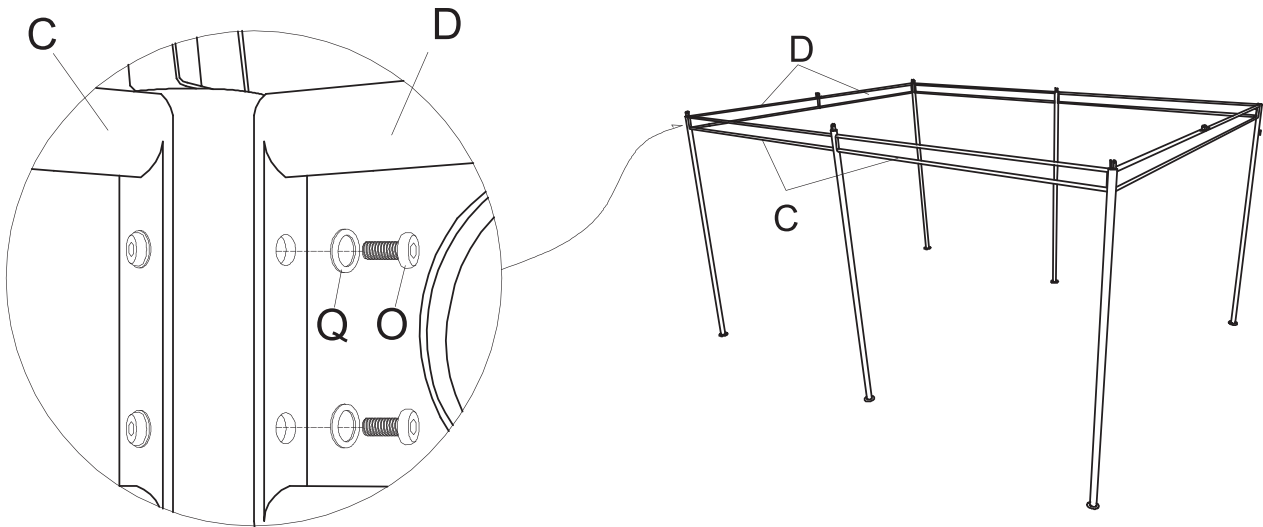

Step 3:

Connect assembled short side beams (in Step 1) and assembled long side (in Step 2) with Bolt III (O) and Washer (Q), form a frame structure

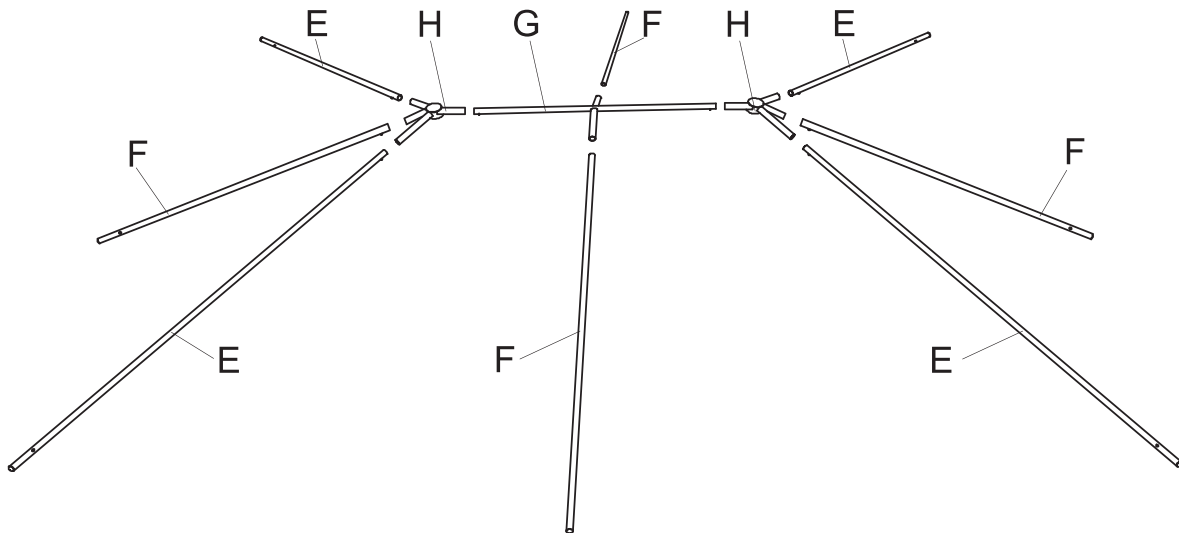

Step 4:

- Put Top center bar (G) between Top fittings (H), then connect each other
 - Connect Top bar II (F) and Top center bar (G)
 - Connect Top bar I (E), Top bar II (F) and Top fittings (H), Top bar I (E) are for four corners
- Form a roof frame structure

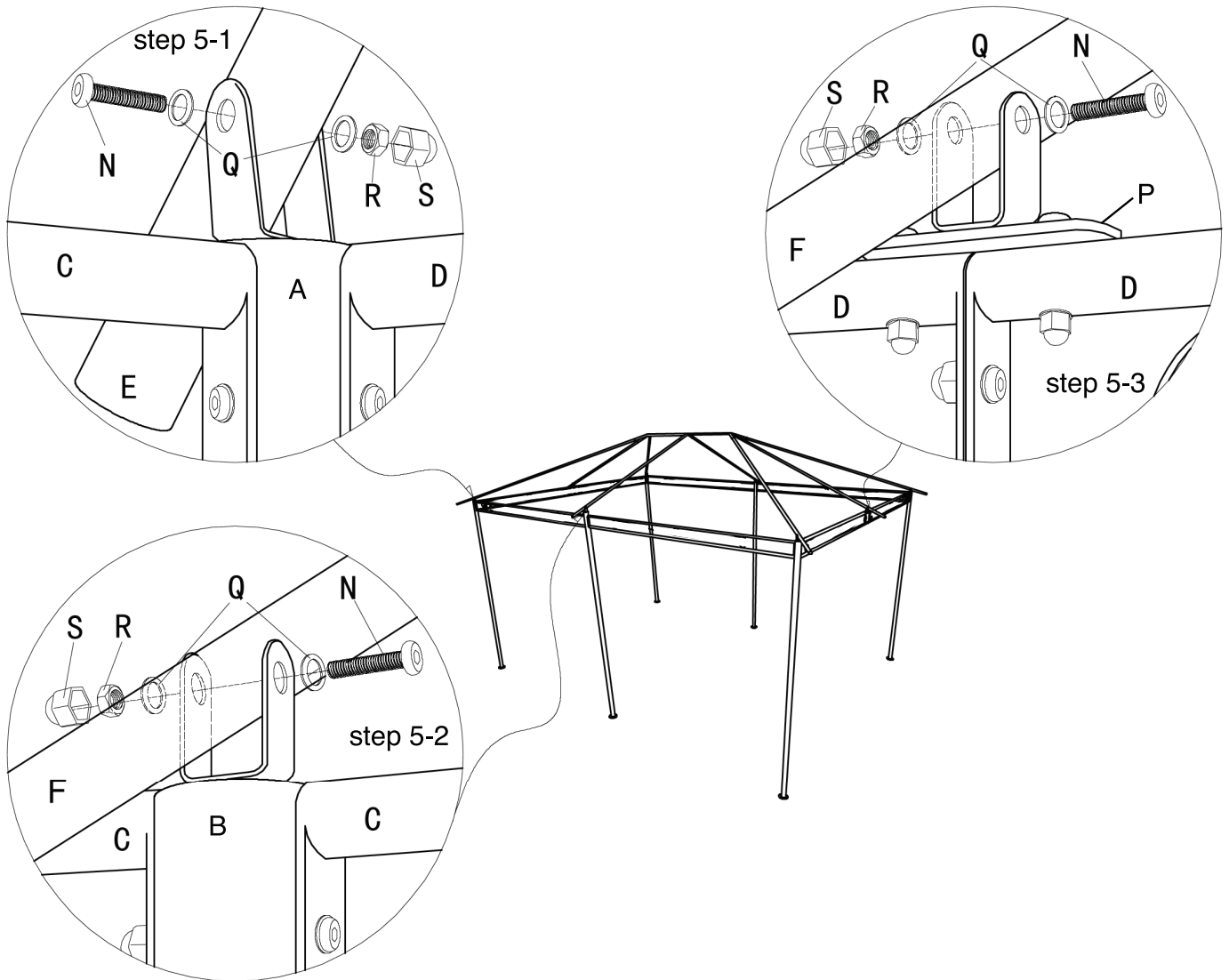

Step 5:

Connect assembled top (in Step 4) and assembled frame (in Step 3) with Bolt II (N), Washer (Q), Nut (R) and Cap (S)

- For four corners, fix Top bar I (E) on the holder of Standing tube I (A) as step 5-1
- In the middle of long side, fix Top bar II (F) on the holder of Standing tube II (B) as step 5-2
- In the middle of short side, fix Top bar II (F) on Connector (P) as step 5-3

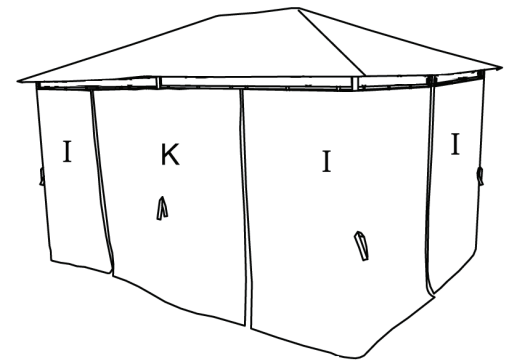
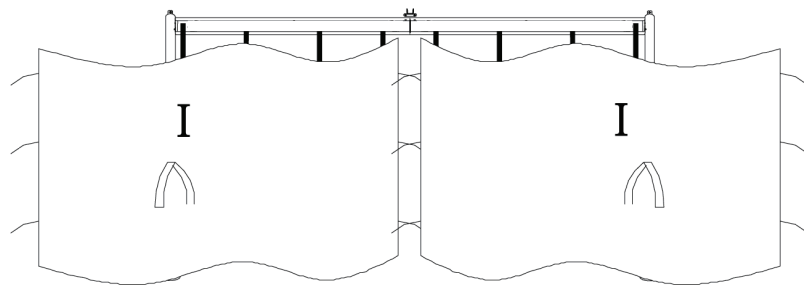
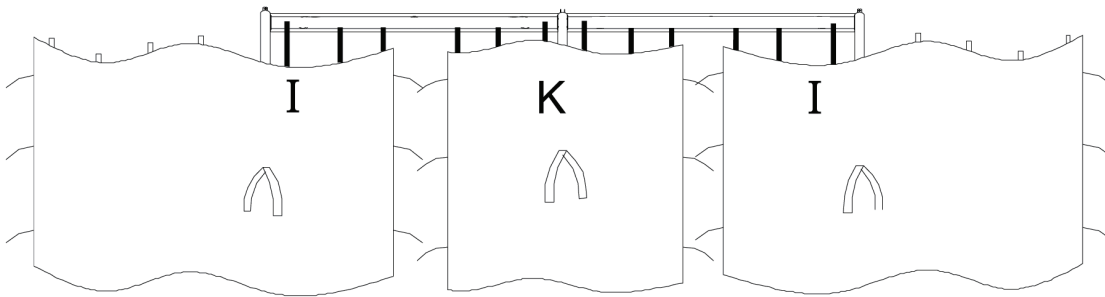
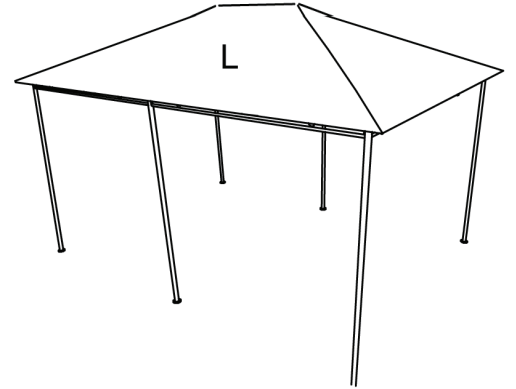

Step 6:

- Place and fix Canopy (L) on the top
- Hang Sidewall II (K) on the middle of two long sides
- Hang Sidewall I (I) on four corners

Now your gazebo is ready for use.