

Steel Square Gazebo

Assembly Instructions - Please keep for future reference

Product Code: 16081

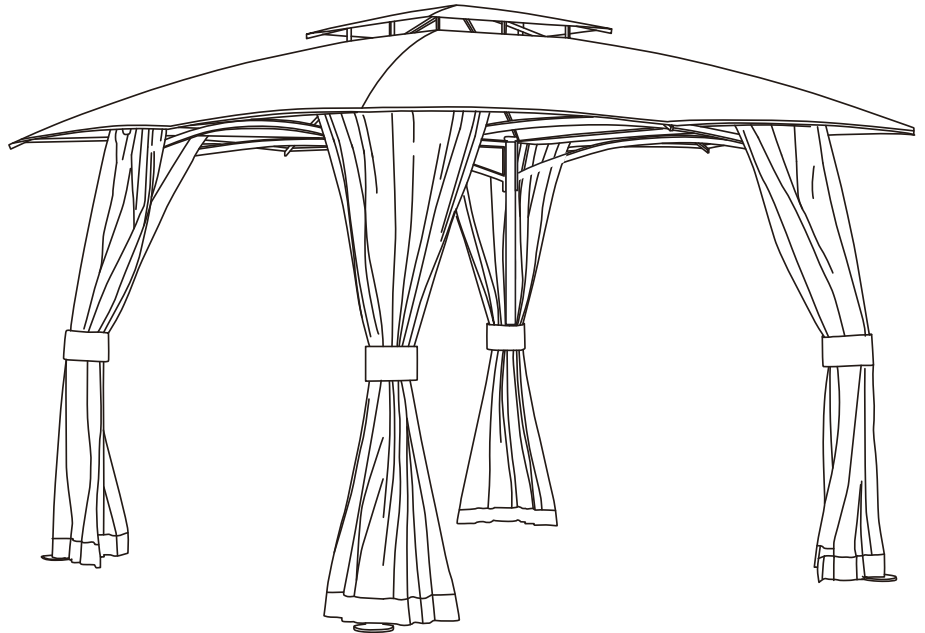

THANK YOU FOR CHOOSING THIS GARDEN COLLECTION PRODUCT.

Please read this instruction manual carefully before beginning to assemble the product. This is an important document, please read carefully and keep safely for future reference.

CAUTION

THIS BAG IS NOT A TOY.
PLASTIC BAGS CAN BE DANGEROUS.
TO AVOID DANGER OF SUFFOCATION,
KEEP THIS BAG AWAY FROM BABIES
AND CHILDREN.
DESTROY BAG BEFORE DISCARDING.

NECESSARY TOOLS

Please check the package contents before attempting to assemble this product. A full checklist of components is given in this leaflet. If any components are missing, please contact the retailer from whom you bought this product.

 The fittings pack contains SMALL ITEMS that could be swallowed, these parts should be **KEPT AWAY FROM YOUNG CHILDREN.**

DISTRIBUTED BY

United Hardware,
Magna Drive, Magna Business Park,
Citywest Road, Dublin 24,
Ireland - D24 KX97

 info@unitedhardware.ie

 www.unitedhardware.ie

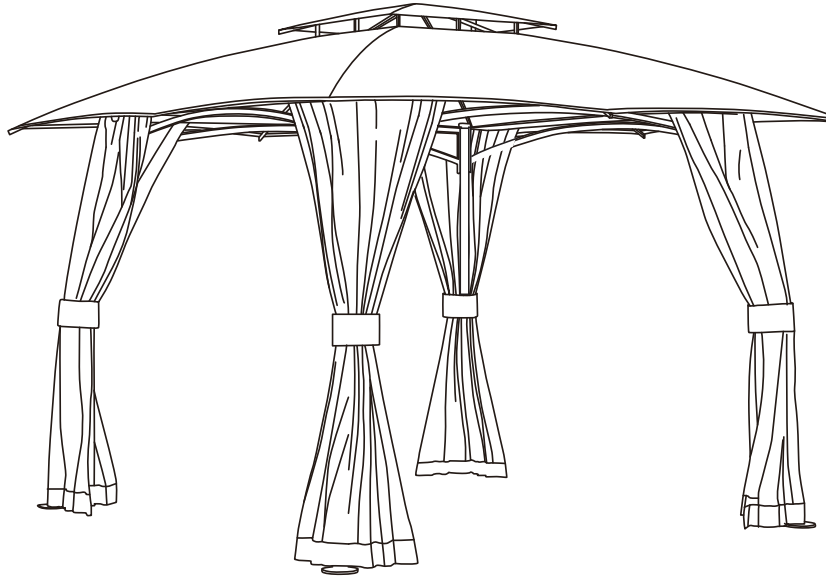

This Gazebo is intended for domestic use only.

We recommend assembly by four or more capable adults under light or no wind conditions.

CARE TIPS

Cleaning: Clean with a damp cloth, do not use bleach or harsh chemicals

Storage: Do not leave this product up in windy conditions, use only in light or no wind. Store in a cool dry place. Avoid exposure to moisture to prevent rust.

Inspection: Ensure that the product is erected correctly before use and that all hardware is tightened before each use.

SAFETY STATEMENTS AND WARNINGS

Do not use this gazebo under windy conditions. Always secure the gazebo while using.

This is not a permanent structure and should be disassembled and stored away

Do not repack your gazebo if wet, allow to dry completely first.

FIRE PRECAUTIONS

Do not use firepits, gas or electric heaters, candles, radiators or any other type of heat or fire source, or flammable liquid in or around the gazebo.

Do not use naked flames in or around the gazebo.







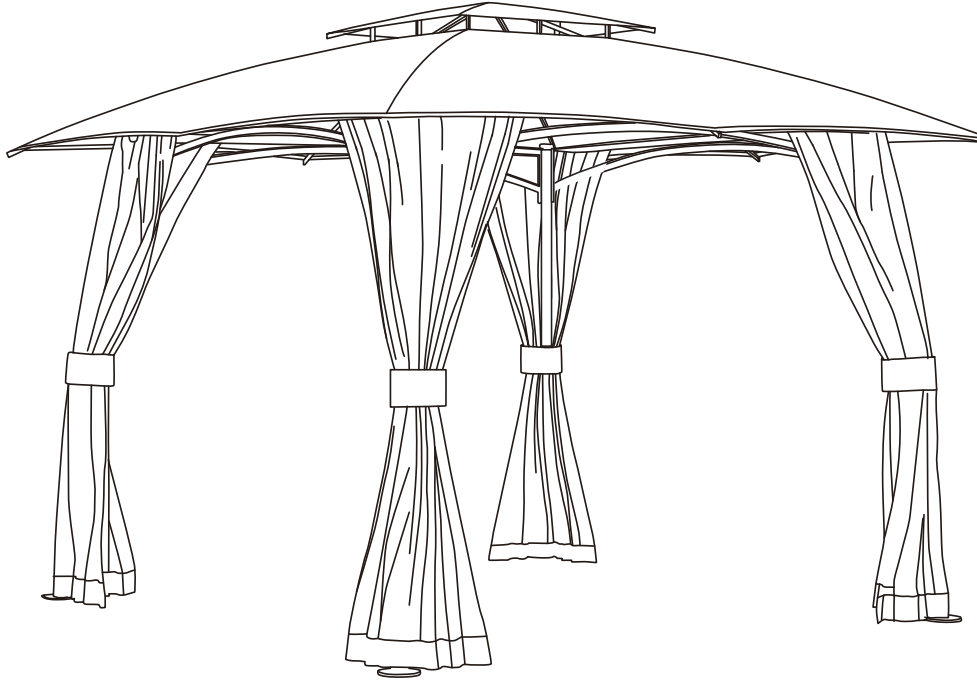

Do not cook or use a BBQ in or around the gazebo







WARNING

The manufacturer and seller disclaim any and all liability from personal injury, property damage or loss, whether direct or indirect or incidental resulting from the incorrect assembly, improper use, inadequate maintenance or neglect of this product.

Assembly Instructions

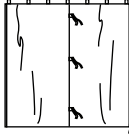
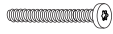

| | | | |
|----------|---|--------------------|------|
| A |  | Standing tube | 4PCS |
| B |  | Beam I | 4PCS |
| C |  | Beam II | 4PCS |
| D |  | Top bar I | 4PCS |
| E |  | Top bar II | 4PCS |
| F |  | Knighthead | 4PCS |
| G |  | Top center fitting | 1PC |
| H |  | Big canopy | 1PC |
| I |  | Base plate | 4PCS |

| | | | |
|----------|---|----------------|-------|
| J |  | Small canopy | 1PC |
| K |  | Top bar holder | 4PCS |
| L |  | Sidewall | 4PCS |
| Q |  | Bolt | 24PCS |
| R |  | Washer | 24PCS |
| O |  | Allen wrench | 1PC |
| Y |  | Peg | 12PCS |

1

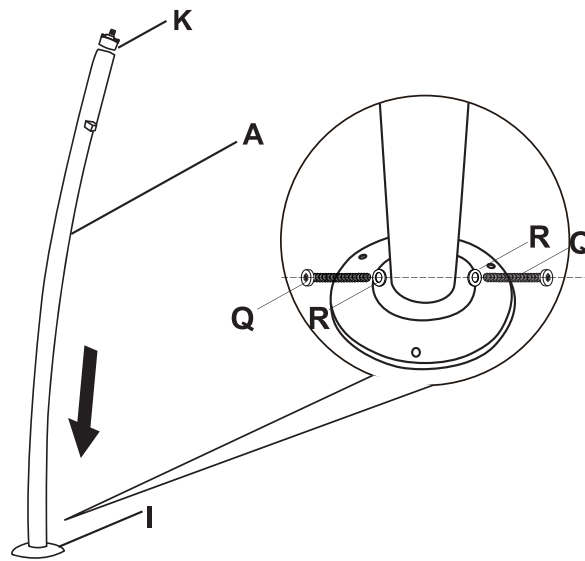

Step 1:

Insert Standing tube (A) into Base plate (I) with Bolt (Q) & Washer (R).
Insert Top bar holder (K) into Standing tube (A)
Repeat this step for rest three legs

2

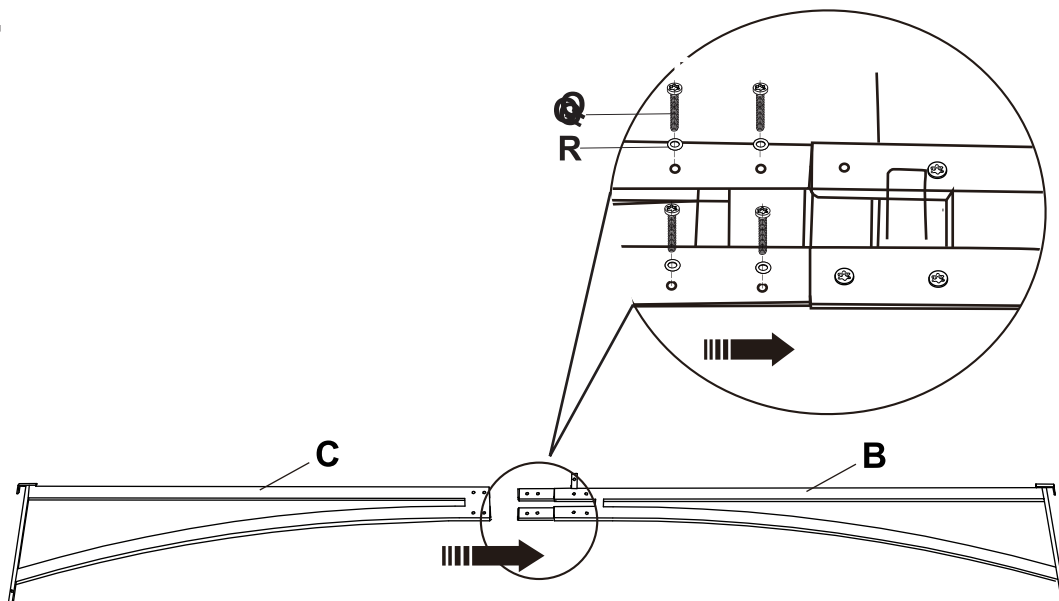

Step 2:

Insert Beam I (B) and Beam II (C) with Bolt (Q) & Washer (R)
Repeat this step for rest three sides

3

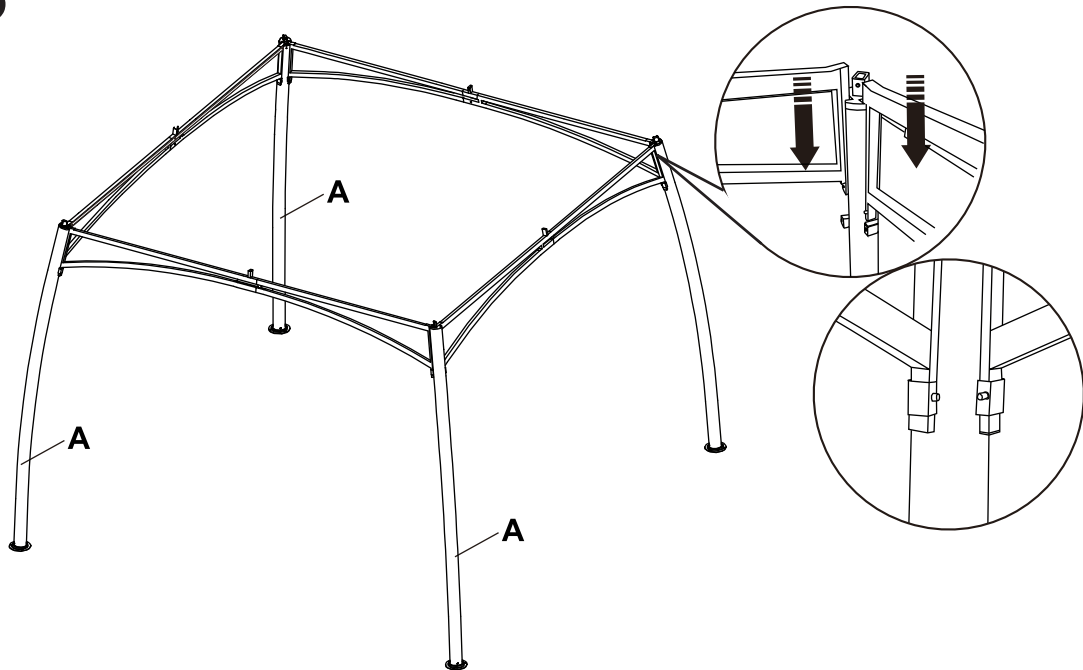

Step 3:

Connect assembled beams (in Step 2) and assembled legs (in Step 1) by inserting beams into the holders on Standing tube (A)

4

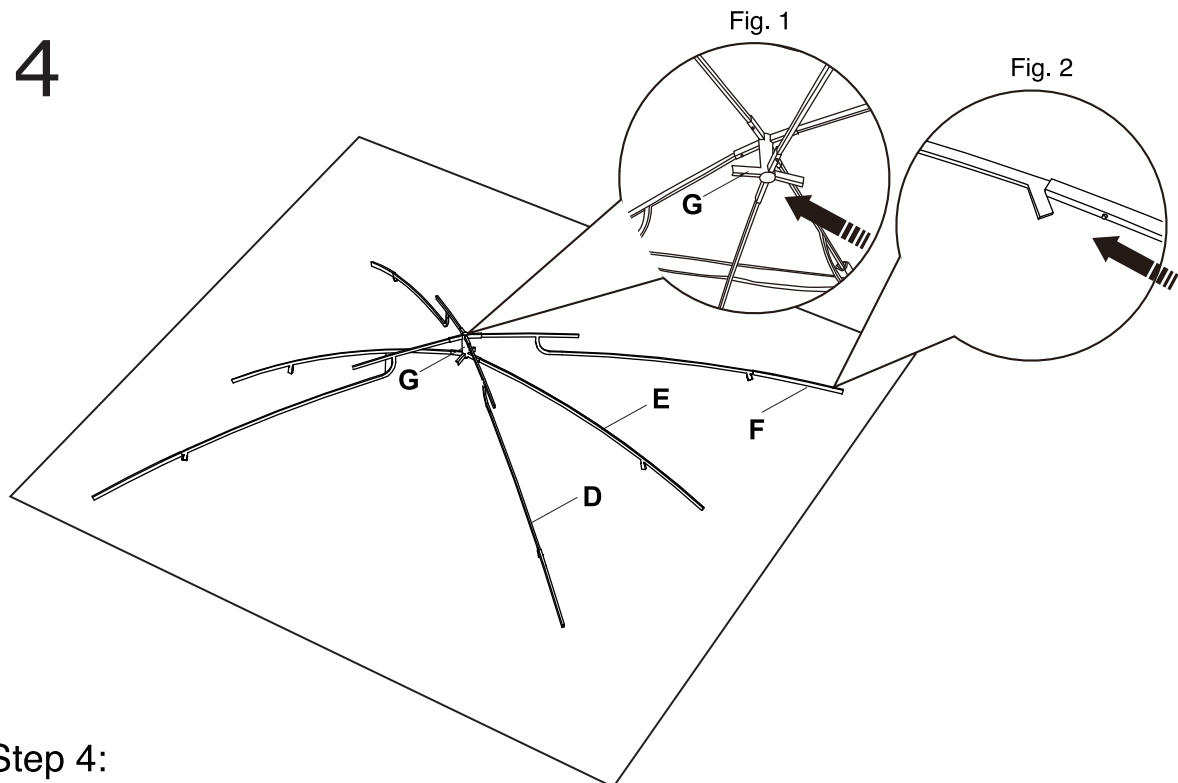

Step 4:

Connect Top bar I (D) into the upper part of Top center fitting (G), connect Top bar II (E) into the lower part of Top center fitting (G), as Fig. 1

Insert Top bar I (D) into Knighthead (F) as Fig. 2

5

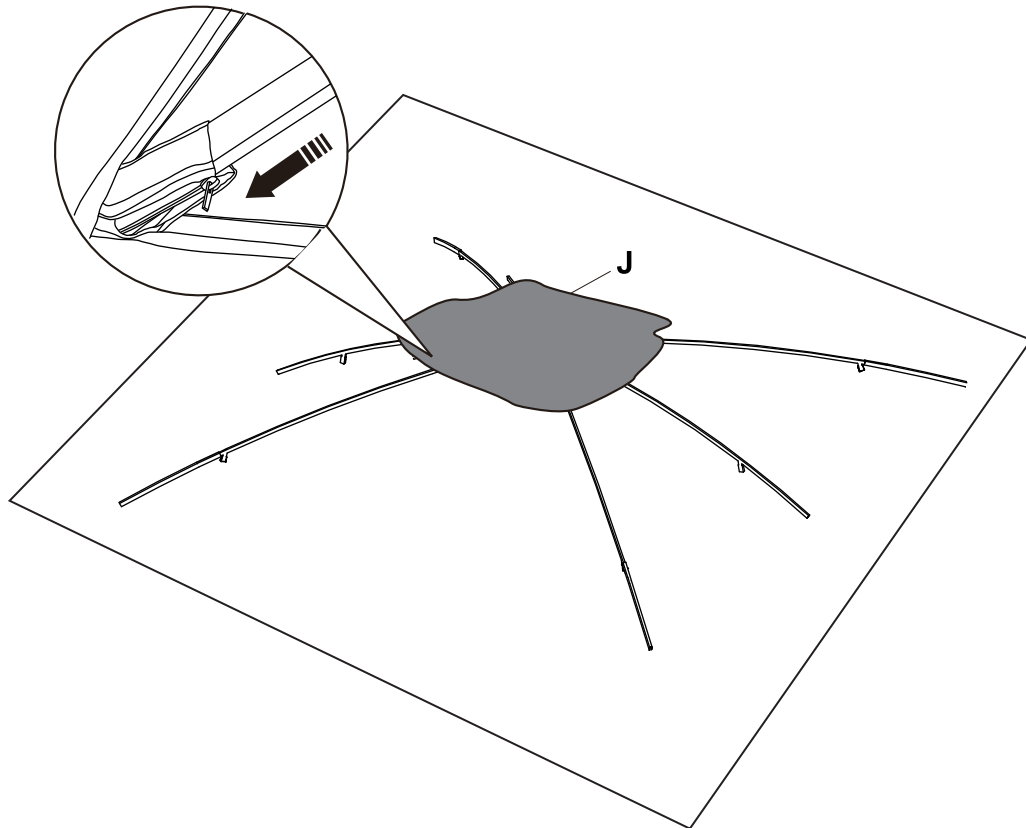

Step 5:

Place Small canopy (J) over the top frame formed by Top bar I (D), once attached, zip up four corner pockets

6

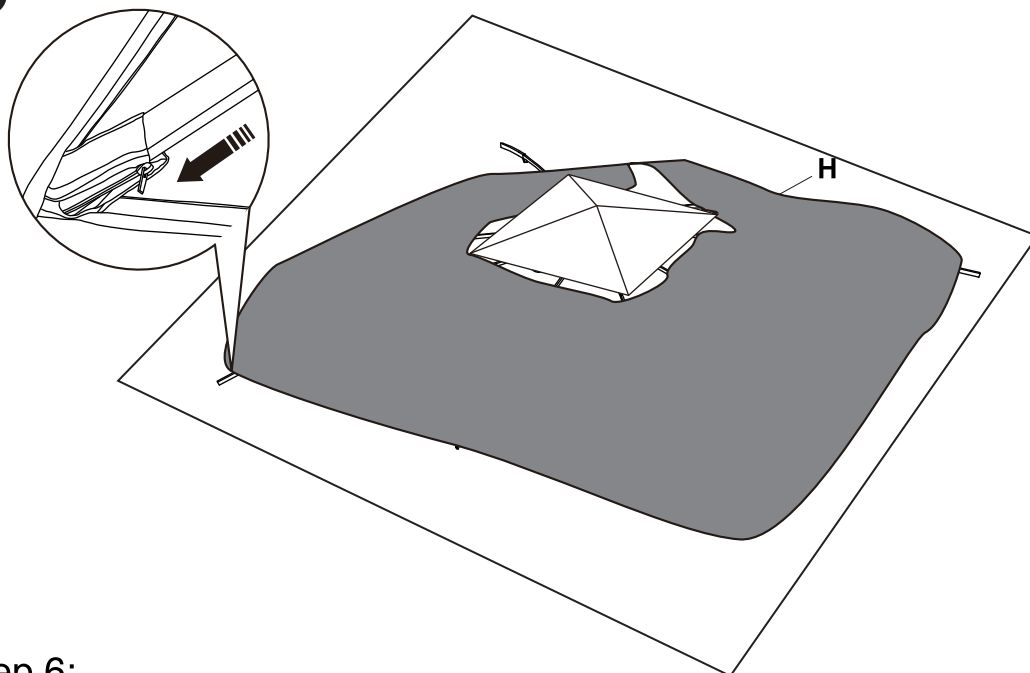

Step 6:

Place Big canopy (H) over the top frame formed by Top bar II (E) & Knighthead (F), once attached, zip up eight pockets



7

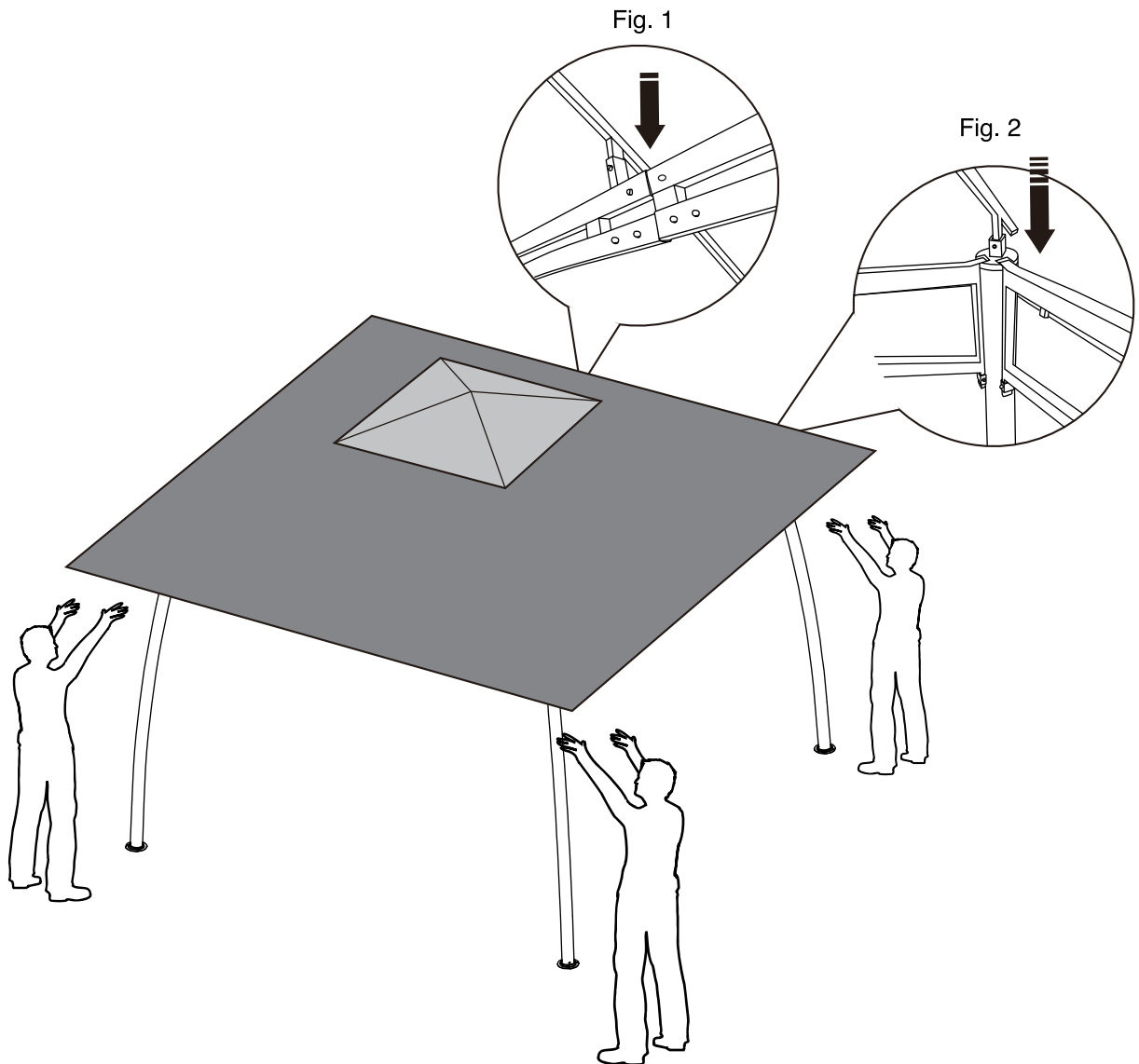

Step 7:

Connect assembled top (in Step 6) and assembled structure (in Step 3):

- Insert Top bar II (E) into the holder on Beam I (B) as Fig. 1, repeat this for rest three sides
- Insert Top bar I (D) into the Top bar holder (K) as Fig. 2, repeat this for rest three corners

8

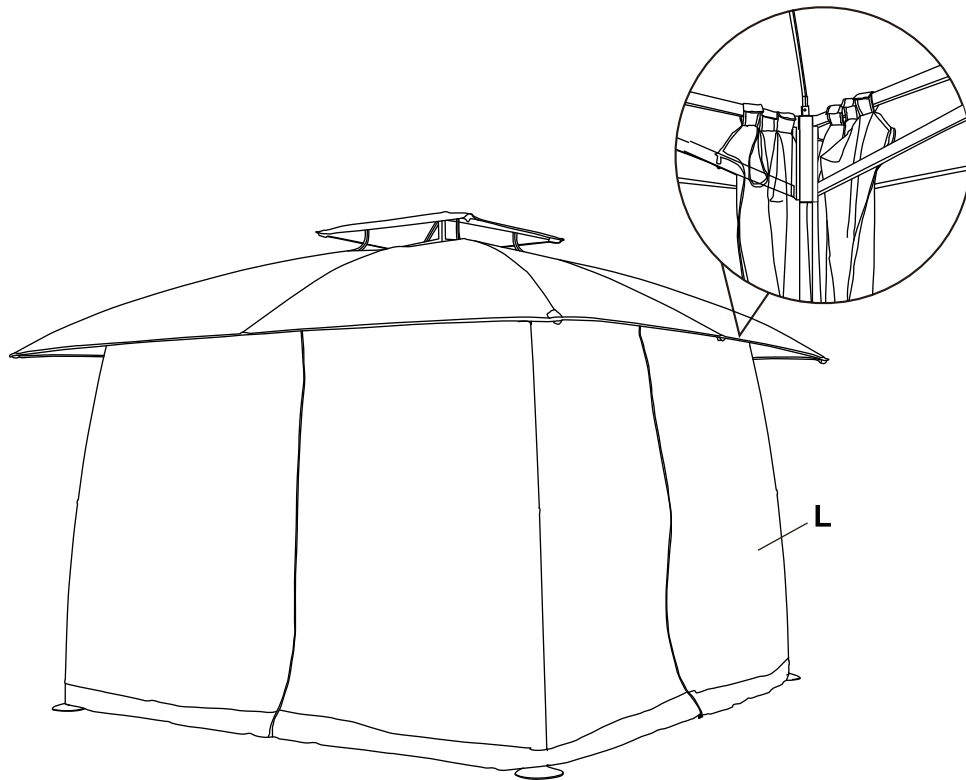

Step 8:

Hang Sidewall (L) onto the top beams (B & C) by fixing the Velcros

9

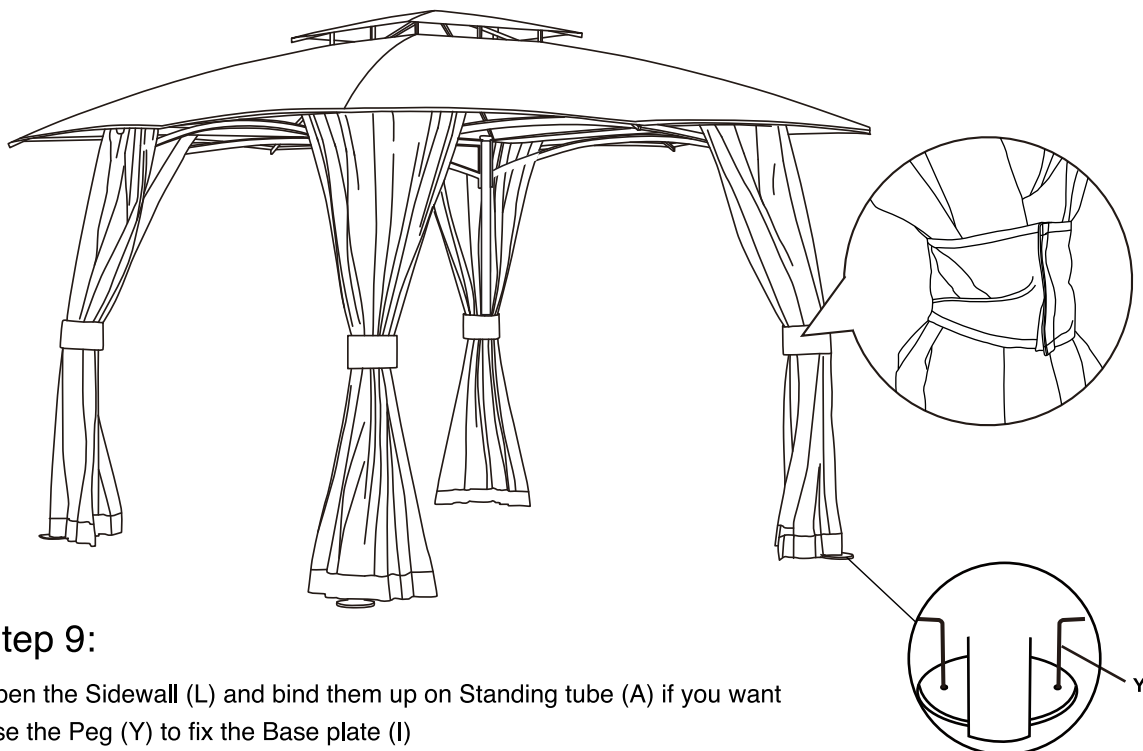

Step 9:

Open the Sidewall (L) and bind them up on Standing tube (A) if you want
Use the Peg (Y) to fix the Base plate (I)

Now your gazebo is ready for use.